

DIGITAL FILE SPECIFICATION CPI BOOKS

2024

CPI Books

Badger Road,
Lordswood, Chatham, Kent, ME5 8TD
T: +44 (0)16 3467 3200

CPI

DIGITAL FILE SPECIFICATION CPI BOOKS

2024

Contents

- 05** Guidelines for supplying text files

- 06** Guidelines for supplying illustration files

- 07** Guidelines for supplying colour digital files

- 16** Font guidelines

- 17** Jacket and printed paper case layouts

- 19** Endpaper layout

- 21** Flapped paperback and flexi bind layouts

- 21** Spine brass file settings and additional notes

Text File Guidelines

Digital data

Please supply PDF files. All files can be supplied via CPI Highway, FTP, email or by using a web based file transfer service. For PDFs, please embed all fonts and use high resolution images. PDF files must be supplied 'upright' with no rotation required. Before submitting any digital data, please ensure you have read this guide fully.

Data format

PDF files should be created by exporting from Indesign. Please embed all fonts and DO NOT subset, DO NOT use security settings, DO NOT downsample images and DO NOT apply any colour profiles to the PDF on creation.

Other Requirements

- When creating a PDF it is preferred that it is supplied with 10mm area all the way around the document. This will include cutmarks and job bleeds.
- When printing double page spreads please pull out the image area from the spine by up to 4mm on the first / last leaf of book or 2mm on other pages, this will ensure readers do not break the spine of the book to read the full spread.
- Files must contain a trim box set to the trim size. All PDF pages must have the same trim box information.
- Text pages should be supplied as single pages not double-page-spreads and combined within one PDF.
- Text pages to be supplied as: Mono – 100% Black, Spot Colour – 100%.
- Text pages should not be supplied as CMYK or RGB, nor should there be any layers or transparencies. As transparencies are on-screen effects only, they have no effect on the final

printed image and will automatically be stripped out by our prepress systems. Any image adjustments should be made prior to PDF creation, transparencies should not be used.

- Halftones should be supplied at a maximum of 60% to reduce set-off and ink drag where these haltones bleed.
- Where multiple images bleed at head and foot there is a risk of ink drag during binding. This can be resolved by sanding copies after binding (additional cost applies).
- All files should be supplied at the correct size. Should enlargements or reductions be required, this should apply to the whole job.
- Re-supplied / corrected files should contain updated information within the naming convention of the file ie. Job Title_Page Number_Revision Number. They should also be supplied the same size and offset as previous.
- There should be no copy within 6mm of the trim including non bleeding text within tint panels.
- When supplying marked-up pages to be corrected, ensure corrections required are clearly marked.
- Please allow a minimum bleed area of 3mm where necessary.
- CPI Books (Chatham) print using cold-set inks. Heavily inked halftones and pages with bleeds are subject to possible set-off and ink transference during production. Additionally, pages with multiple bleeds at the head and foot of the page can lead to 'ink drag' during trimming. Whilst everything is done to reduce the effects, it's not always possible to remove them entirely. Please speak with your CSE for more advice on how to counter this when setting up files.

- Printers details on the imprint page should read:
Printed and bound by CPI Group (UK) Ltd, Croydon, CR0 4YY

Illustrations File Guidelines

Digital data

We accept PDFs or Application Files. All files can be supplied via CPI Highway, FTP, email or by using a web based file transfer service. For PDFs, please embed all fonts and use high resolution images. PDF files must be supplied 'upright' with no rotation required. Do not leave errors uncorrected and ensure a colour proof is supplied for content. If you wish to supply Application Files, please contact your Customer Service Executive for more information on our pre-press services and a full list of prices. Before submitting any digital data, please ensure you have read this guide fully.

Data format

PDF files should be created by exporting from Indesign. Please embed all fonts and DO NOT subset, DO NOT use security settings, DO NOT downsample images and DO NOT apply any colour profiles to the PDF on creation.

Halftones/images

To be CMYK or greyscale @ 300dpi or above. Linework to be Bitmap Tiff @ 1200dpi or above - do not convert greyscales to Bitmap Tiffs if they are lower than specified resolution and always convert using the '50%threshold' setting.

Other Requirements

- When creating a PDF it is preferred that it is supplied with 10mm area all the way around the document. This will include cutmarks and job bleeds.
- All files should be supplied at the correct size. Should enlargements or reductions be required, this should apply to the whole job.
- Re-supplied / corrected files should contain updated information within the naming convention of the file ie. Job Title_Page Number_Revision Number. They should also be supplied the same size and offset as previous.
- When supplying marked-up pages to be corrected, ensure corrections required are clearly marked.
- Pages should be supplied as single pages not double page spreads.
- Please allow a minimum bleed area of 3mm where necessary.
- Files must contain crop marks. These are to be offset by 4mm.
- Files must contain a trim box set to the trim size.
- All PDF pages must have the same trim box information.

Digital Colour Files

Digital data

We accept PDFs or Application Files. All files can be supplied via CPI Highway, FTP, email or by using a web based file transfer service. For PDFs, please embed all fonts and use high resolution images. PDF files must be supplied 'upright' with no rotation required. Ensure trim and spine marks are included and do not leave errors uncorrected. A colour proof should be supplied for content. All colour files should be supplied combined as one PDF including spot colours. If you wish to supply Application Files, please contact your Customer Service Executive for more information on our pre-press services and a full list of prices. Before submitting any digital data, please ensure you have read this guide fully.

Data format

PDF files should be created by exporting from Indesign. Please embed all fonts and DO NOT subset, DO NOT use security settings, DO NOT downsample images and DO NOT apply any colour profiles to the PDF on creation.

Halftones/images

To be CMYK or grayscale @ 300dpi or above - layered files preferred if available Linework to be Bitmap Tiff @ 1200dpi or above - do not convert grayscales to Bitmap Tiffs if they are lower than specified resolution and always convert using the '50%threshold' setting.

Finishes

Spot UV, Emboss, Foil, etc should be supplied as solid spot colours, overprinting the 4-colour work, on a single application/PDF page. If you are unable to do this, supply them as separations, coloured 100% black. We will then convert them to spot colours and combine them with the 4-colour file to ensure good fit and correct content, although there may be a charge for this.

PDF Samples

CPI recommends a maximum ink coverage of 300% on coated materials and a maximum coverage of 240% on uncoated materials (including inners of covers).

Colour Digital Files

To create a new job in InDesign the page size must match the desired trimmed book size eg: A Cover made up with a 198mm x 129mm board size and a 30mm spine will be 288mm in width by 198mm in depth.

$$129\text{mm Back cover} + 30\text{mm Spine} + 129\text{mm Front cover} = 288\text{mm}$$

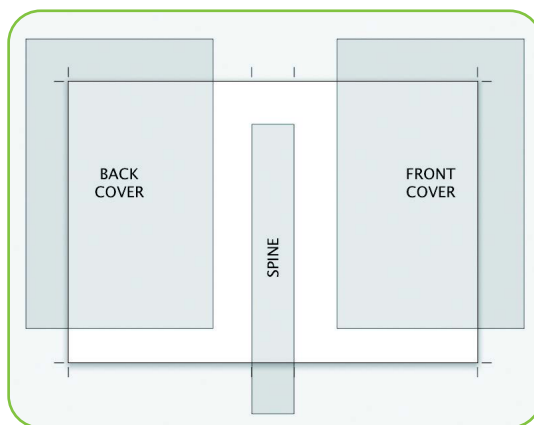
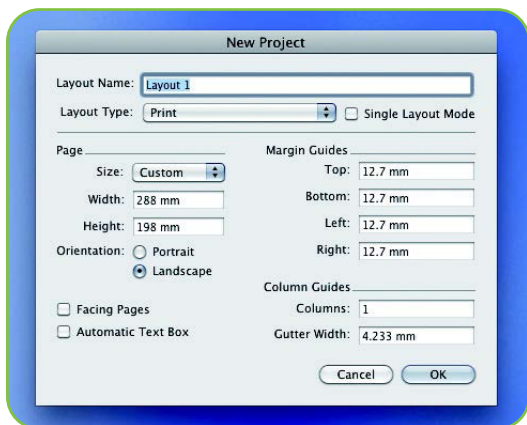

When assembling a document the picture boxes must include the board sizes and bleed which is normally unless instructed 3mm.

The bleed is extra image on the side of a document that ensures that no unprinted edges occur in the final trimmed document.

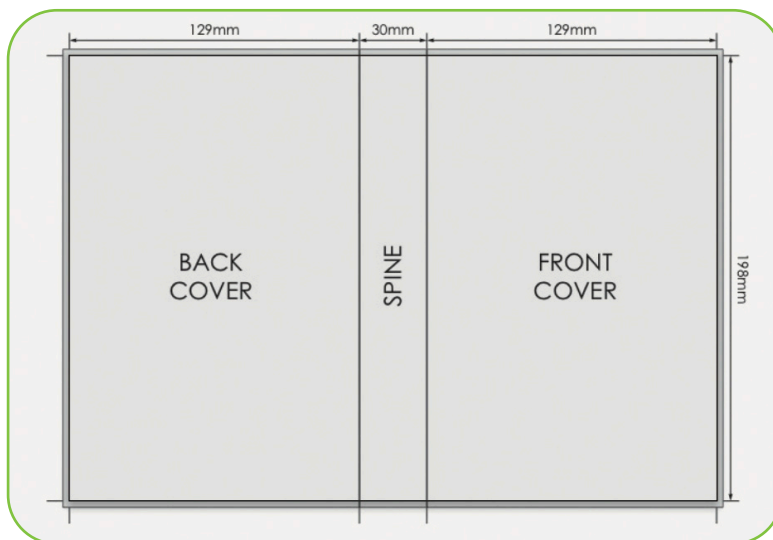

$$\text{For example: } 129\text{mm} + 3\text{mm} = 132\text{mm width}$$

$$198\text{mm} + 3\text{mm top} \& 3\text{mm bottom} = 204\text{mm depth.}$$

When positioning picture boxes in InDesign they must butt up against each other to eliminate gaps in the printing. If this is not done correctly it will normally result in a white line showing.

For example: A 129mm Picture box used as a back cover with 3mm bleed will be 132mm in width. 3mm of this box will be outside the document area for bleed so the next Picture box used for the spine will start at a position of 129mm.

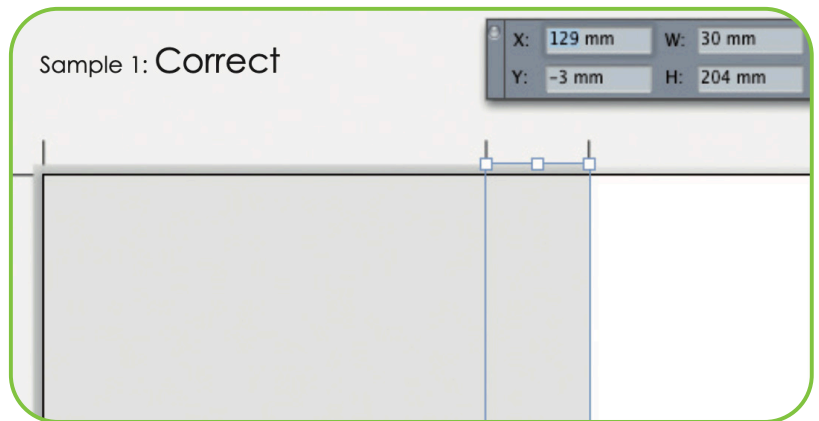

As you can see from the incorrect version there is a white gap between the two image boxes which would show when printed. This is a result of the Picture box not starting at the 129mm coordinate as in the correct sample 1.

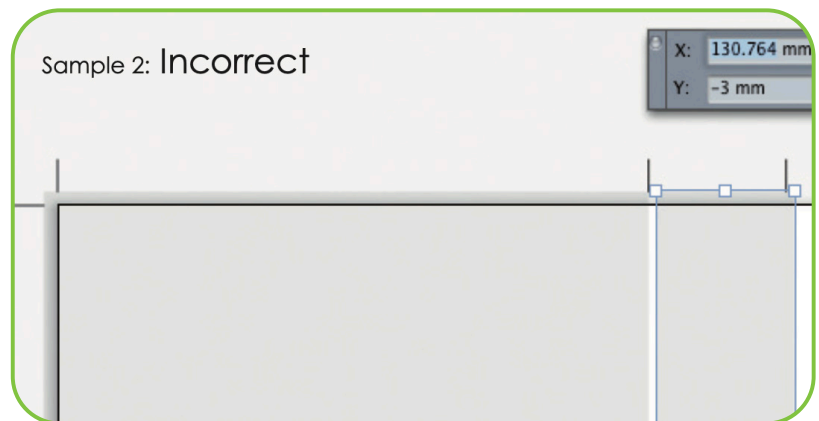

Inner Component Printing

When a Cover or Jacket has inner printing it should match the outer files exactly for dimensions and layout. For example the same board size and spine size etc. This is very important so when the files get printed the Inners back up to the outer printing on press.

It is standard practice that the spine is left white / has no ink printed on it +1.5mm either side for standard 2 score bound work or +3mm either side for 4 score work. This allows for the glue to adhere to the cover when the books are assembled. Ink densities should also on the inner be kept to a maximum of 240% as the Inner of the board is an uncoated surface.

Outer Printing

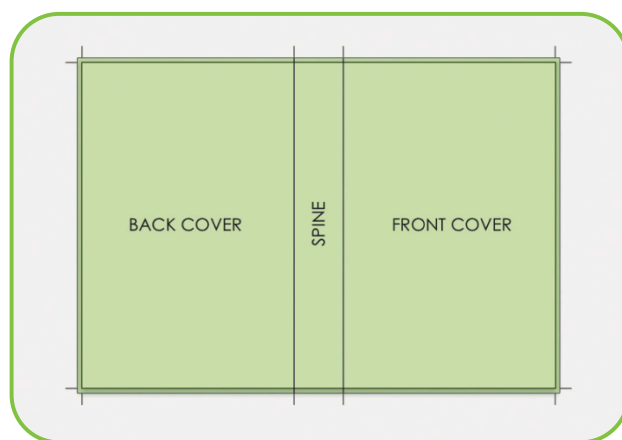

Inner Printing

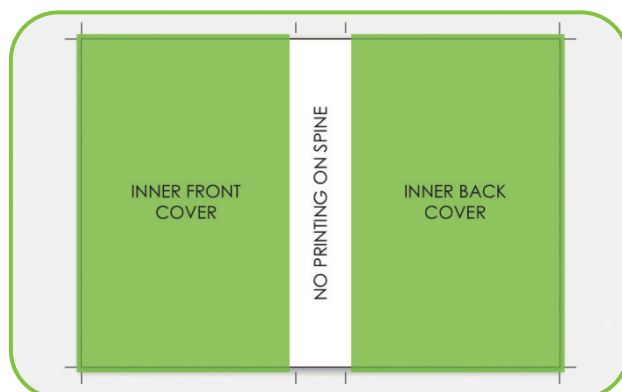

+1.5mm either side of spine (standard 2 score)
+ 3mm either side of spine (standard 4 score)

Colour Information

The colour of a finished book is obviously very important. When producing a book cover or jacket there are some rules to help achieve this.

For example: When creating a solid black panel it is useful to colour it 100% black and 50% cyan. This is known as a shiner or booster and will improve the look and density of the black panel. Without this shiner / booster it will look less rich and sometimes slightly grey.

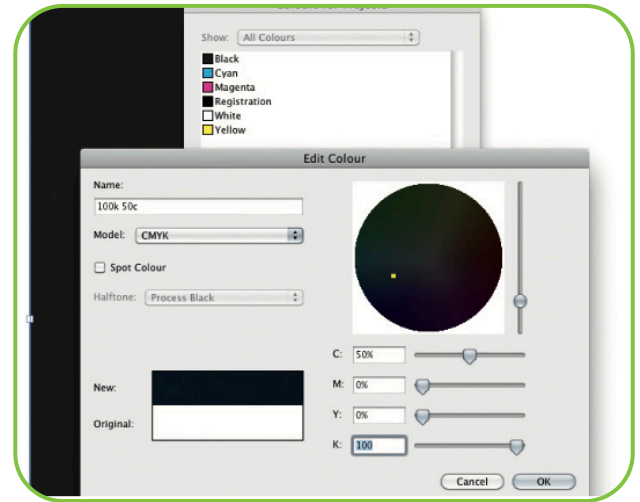

100% BLACK WITH
NO SHINER

100% BLACK WITH
50% CYAN SHINER

When designing a very rich or dark colour scheme out of all 4 process colours, it is recommended that you try to keep the maximum ink coverage below 280%. This means when you add-up the CMYK percentages it should not exceed this total. Going over this percentage could cause the inks to run, lengthens drying times and could cause problems with finishes. Ink that is not dry can also be transferred to the foredge of the books when trimmed in the bindery.

The Registration colour should only be used for cutmarks and foldmarks.

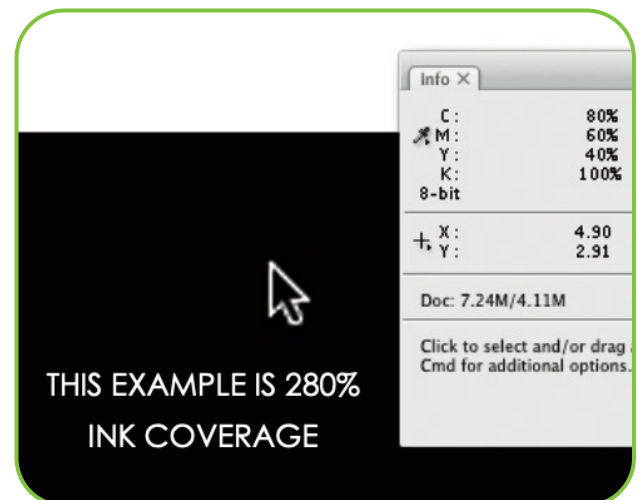

INK COVERAGE TOO HEAVY
OVER 280%
LONG DRYING TIME.

Images

When creating and using CMYK or grayscale images they should be a minimum of 300dpi when in a document at 100% size. This is an industry standard and a 300dpi image will give you a good result where as a low resolution image will look blocky and pixilated.

Colour images should be supplied in CMYK and can be layered. This will sometimes change the colour of a supplied image and this is most noticeable in neon or fluorescent looking colours.

Hi Res



Low Res

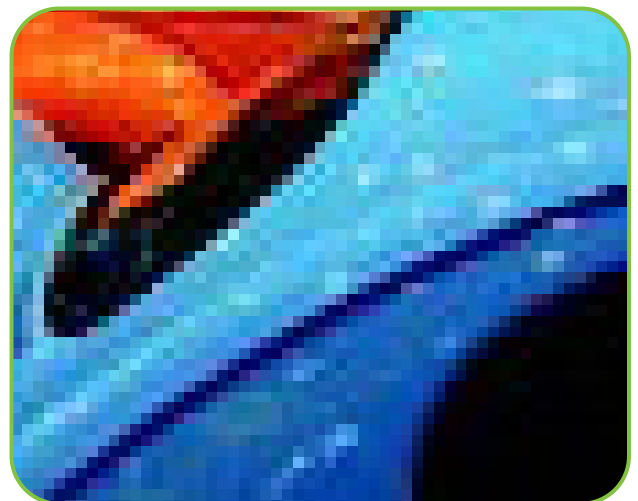

When producing or using Bitmap files they should be supplied at a maximum of 1200 dpi or a minimum of 500dpi. If creating a Bitmap from a grayscale do not convert grayscales to Bitmap Tiffs if they are lower than the specified resolution and always convert using the '50% threshold' setting.

Hi Res Bitmap Tiff



Low Res Bitmap Tiff



Finishes

The finishing process is normally applied to a job after it has been printed and can consist of many processes ranging from Spot UV, Foiling, Embossing and Debossing.

The finishing files should be set up and layed out in the same way as the cover or jacket files and are just as important. These files should match the 4 colour work exactly in size and position and be made 100% of a single solid colour.

The finishing can be incorporated into the 4 colour work by overprinting them or by putting them on a layer. If they are put into a second page and not incorporated in the 4 colour work it is important that they correspond exactly.

Embossing should not bleed at the trim. Embossed areas should not fall within 3mm of trimmed edge, or cover spine.

It is not recommended that foil blocking areas are reversed out from the print image as this can cause problems with register.



Version 1: Good Fit

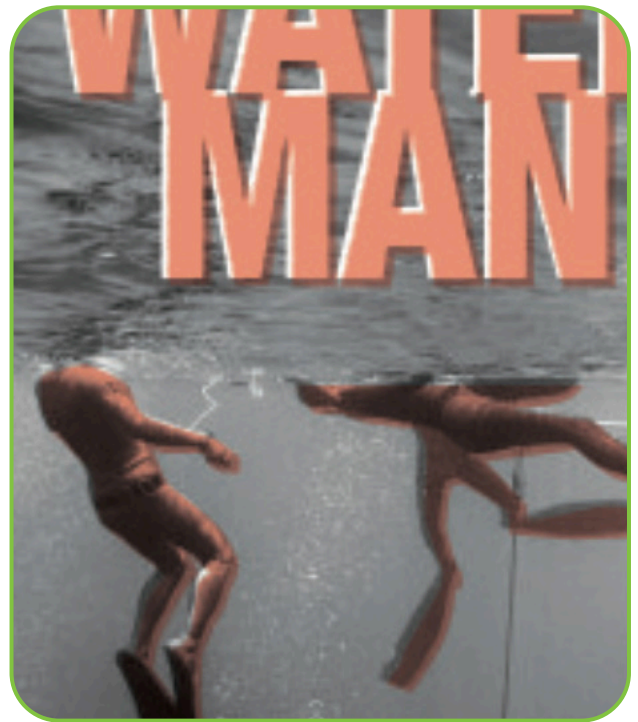

Version 2: Bad Fit

Example: Version 1 is a good fit for a Spot UV and would give the desired finish. Version 2 has not been positioned correctly and could be finished wrong.

Guidelines for Cover Designers

There are certain variables that can affect components during production and though on their own they can be small, they can combine to affect the final design on the trimmed book.

It is useful therefore to follow some basic guidelines:

Type and non-bleeding images such as logos, flashes etc., should be withdrawn 4mm from book trims.

Make sure the spine size is correct for cover/jackets/cover for case.

Ensure Job has both trim and spine marks and are coloured in registration. Type & logo on a spine up to 10mm needs to have a minimum clearance of 1mm to folds. This should be increased to 2mm on spines up to 30mm, then increased to 3mm on spines exceeding this.

Kiss fit images need to be spread/choked to give better fit in final printing.

Job must have a minimum of 3mm bleed.

Number of colours in digital data match Publishers orders.

Make sure trim sizes are correct.

Finishing data must be in one spot colour and solid (e.g 100% tint).

Finishing data must fit colour area exactly.

Foiled fine lines/details are at risk of filling in. We recommend a minimum line width of 0.5mm to give best results.

CPI recommends cover/jacket/PPC foil is applied UNDER any laminate wherever possible to encapsulate and protect the foil from damage. A spot uv can be applied over the foil areas to return shine as required. Where a laminate is not used or foil is applied over laminate, we ask that you please be aware that in these instances the foil is left exposed to potential marking/flaking.

Card tip at front OR back OR both with inside cover printing:

Image to bleed 2mm into spine on inside front OR inside back cover. This should help to avoid white line between cover & tip.

2pp card tip:

No foil or varnish to appear within 3mm unsewn allowance & 3mm in trimmed back (i.e. 6mm unfinished area in total) to facilitate binding.

Lamination is not possible. Printing on the uncoated side of the board for a double cover tip-in is recommended if colour matching to the inside front cover. Alternatively, you may wish to consider printing the cover on double-sided board with the tip-in printing on the coated side (prices available on request).

PDF

When creating a PDF it is preferred that it is supplied with 10mm area all the way around the document. This will include cutmarks, foldmarks and the jobs bleed. Below is a PDF that is 288mm x 198mm + 10mm all round = 308mm X218mm.

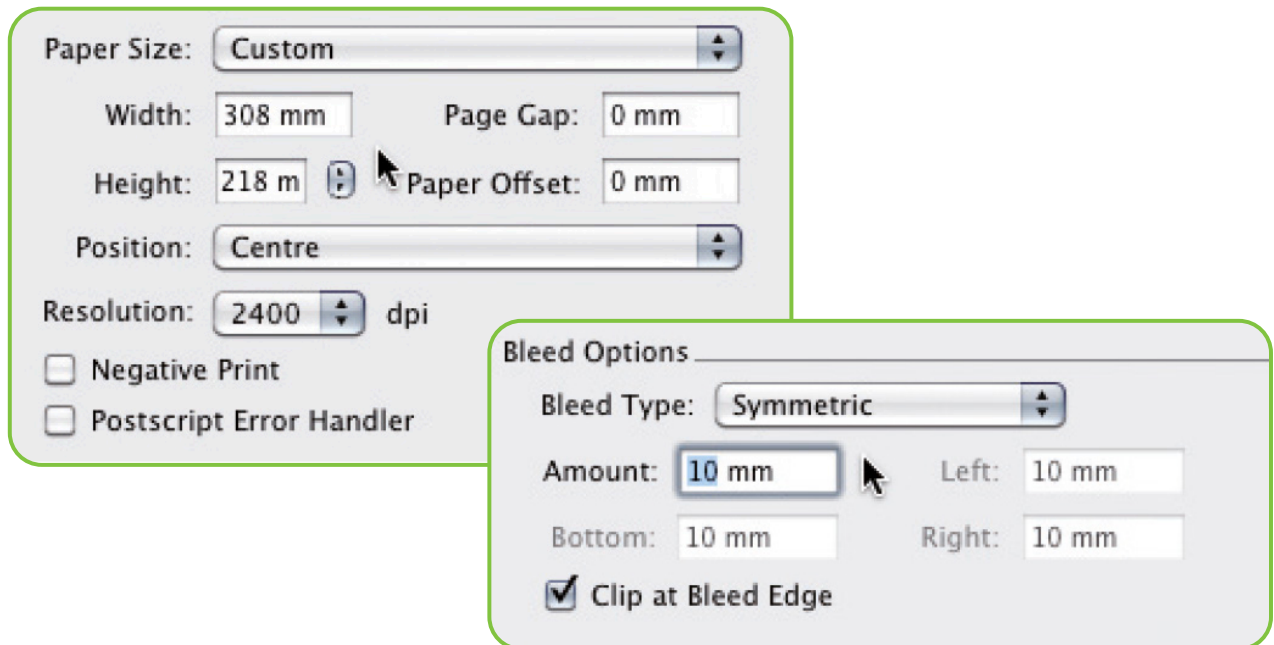

Example of a supplied cover with 10mm border all round PDF

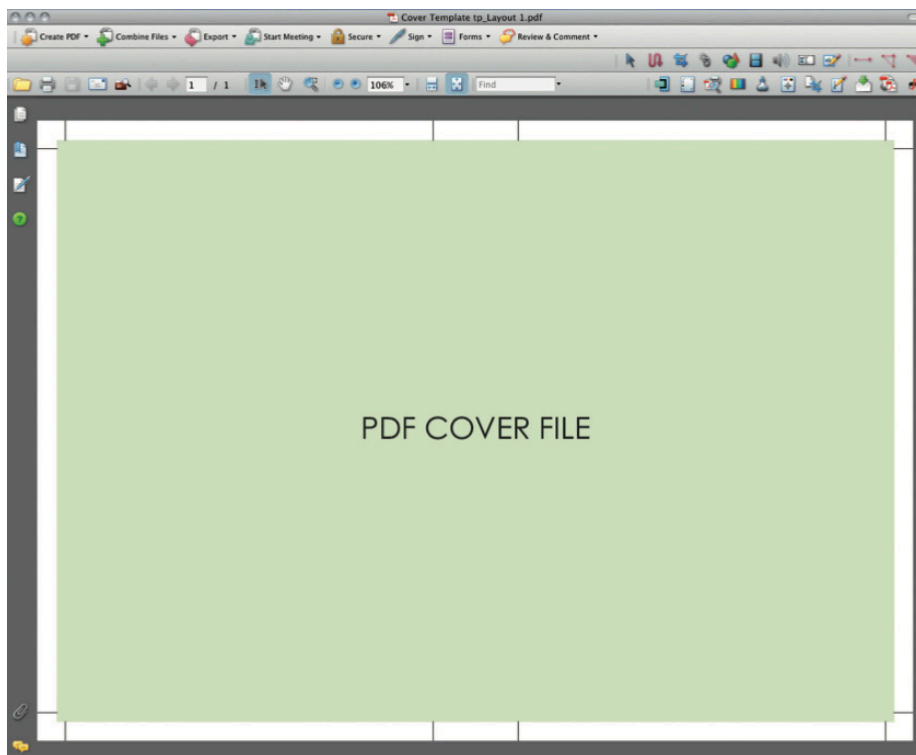

Please Note: For Print On Demand (Antony Rowe Eastbourne), transparencies must be flattened

Fonts

Changing fonts in InDesign should be done in a specific way. The desired type should be selected and then using the tool bar select the correct font and style in the pop up menu...

The example below is the **CORRECT** way to select a font:



The example below is the **INCORRECT** way to select a font:

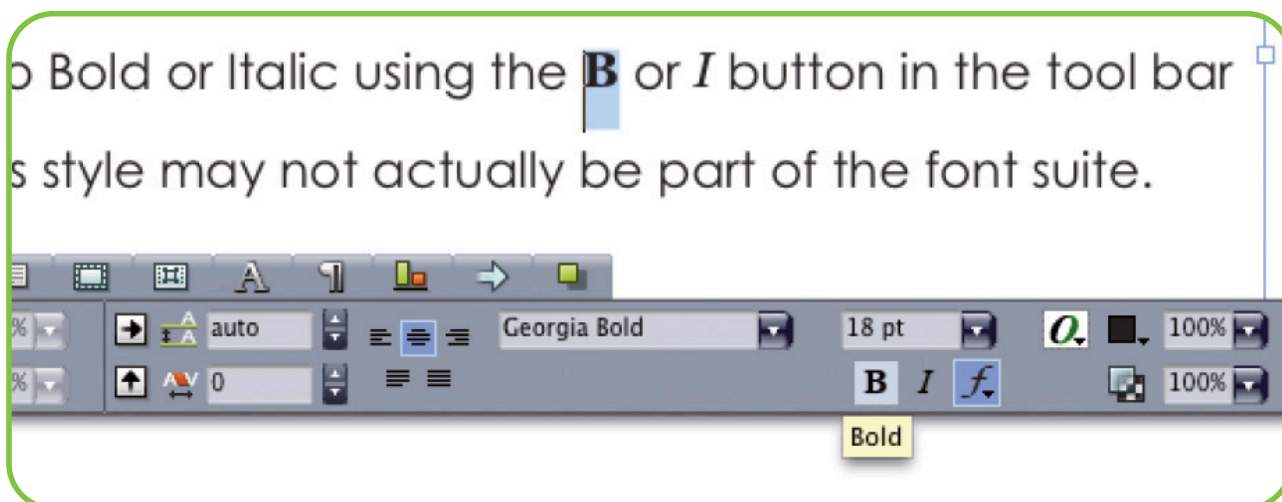

Manually forcing a font to **Bold** or *Italic* using the **B** or *I* button in the tool bar could cause problems with the type as this style may not actually be part of the font suite. Changing a font in this way will normally look ok on screen but could drop out when a print ready pdf is created. This will sometimes result in the font reverting to its normal state i.e not bold or changing to default `courier` font.

Jacket Layout Details

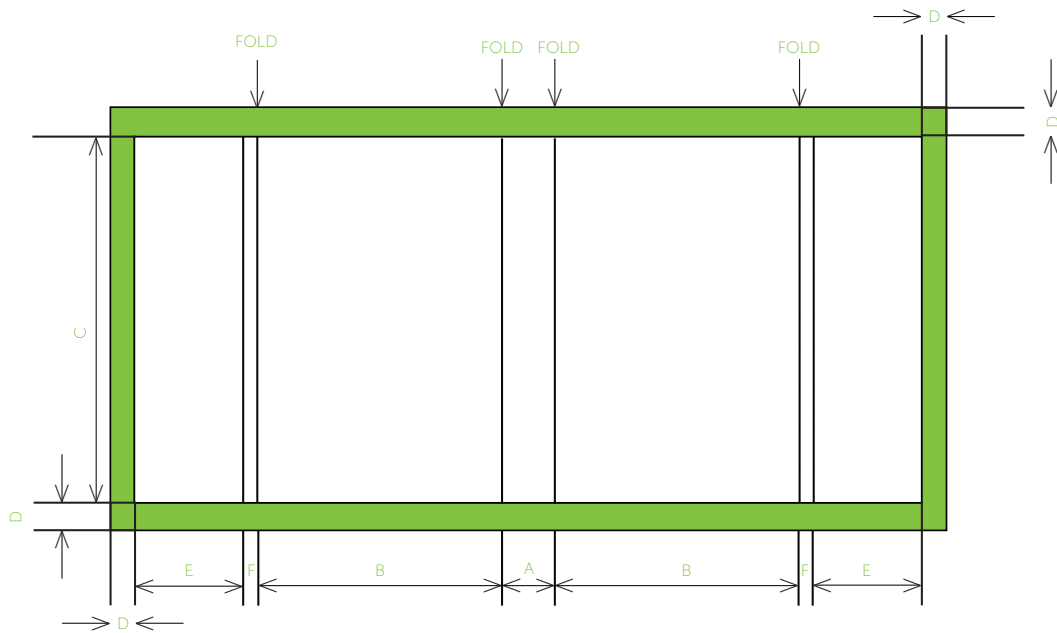

- A** = Using 2mm Boards - Spine Bulk + 4.8mm
Using 3mm Boards - Spine Bulk + 7mm
- B** = Trimmed page width + 3mm
- C** = Trimmed page Height + 6mm
- D** = 3mm (for bleed)
- E** = ROYAL flap size minimum of 50mm / maximum 123mm
DEMY flap size minimum of 50mm / maximum 105mm
BFORMAT flap size minimum of 50mm / maximum 99mm
AFORMAT flap size minimum 50mm / maximum 81mm
- F** = 8mm - Area wraps around the board and back into the book
(visible on a closed book)

PPC Layout Details

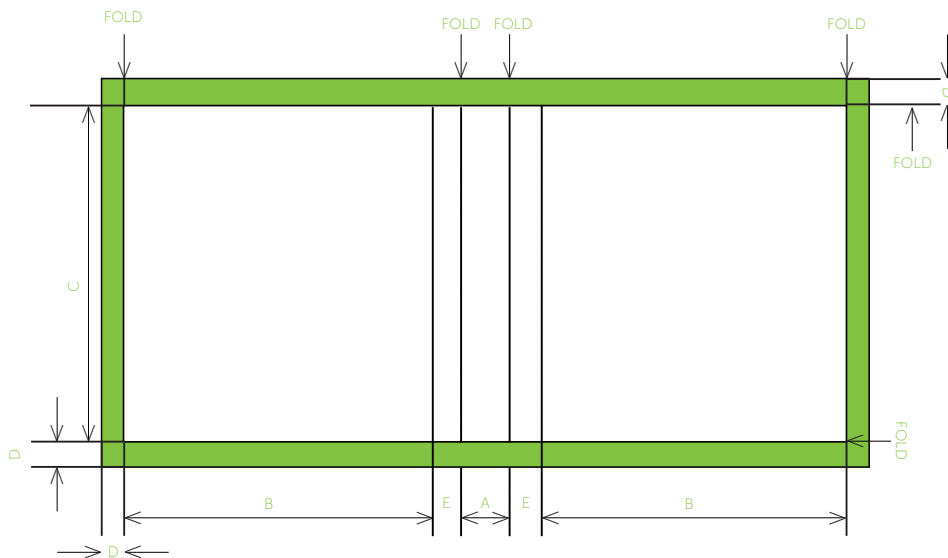

A = Square Back with 3mm Boards + 4.5mm
Square Back with 2mm Boards + 2.8mm
Round Back + 4mm

B = Round & Back: Trimmed page width – 4mm
Square Back: Trimmed page width - 6mm
All spine widths rounded up to the nearest whole number

C = Trimmed page Height + 6mm

D = 15mm

E = Square Back 12mm / Round Back 8mm

This area to be considered when designing/centering images on Front and Back
Please discuss this with your Account Controller

Note: When using a CPI Spine Calculator, the extra in Area A for Jacket and PPC is already included. Please note dimensions given for PPCs are based on the size of the hollow used to make the case, it is the publishers decision on whether the image should roll slightly to the front of the book or end on the hollow.

Endpaper Layout

ENDPAPER GUIDANCE

To protect the back fold, endpapers are applied slightly further forward on the text block when binding therefore it is advisable to plan endpaper designs based on a slightly reduced page width as below. This is particularly key for maps and bordered images.

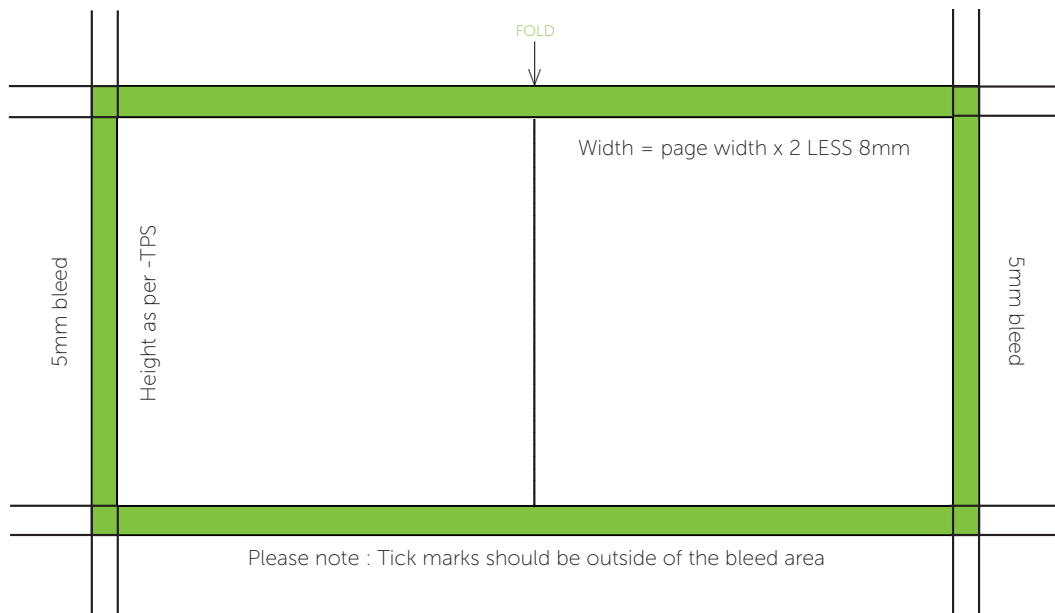

Format	Endpaper Height (+ 3mm bleed head and foot)	Width across the spread (plus 5mm bleed each side)
A	178mm	214mm
B	198mm	250mm
DEMY	216mm	262mm
ROYAL	234mm	298mm

Flapped paperback & flexi bind layout details

FLAPPED PAPERBACK LAYOUT DETAILS

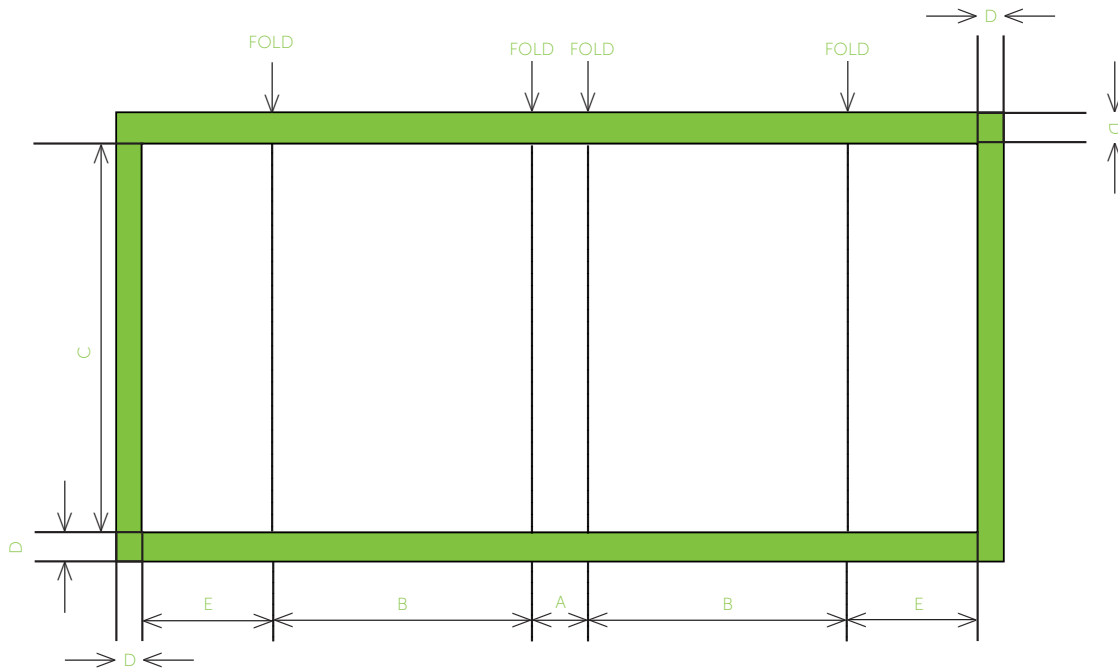

- A** = Spine Bulk
- B** = Trimmed page width + optional 2mm (do not add if required flush)
- C** = Trimmed page height
- D** = 3mm (for bleed)
- E** = ROYAL flap size minimum of 95mm / maximum 135mm
 DEMY flap size minimum of 90mm / maximum 115mm
 BFORMAT flap size minimum of 85mm / maximum 90mm
 AFORMAT flap size needs to be 75mm only

FLEXI BIND LAYOUT DETAILS

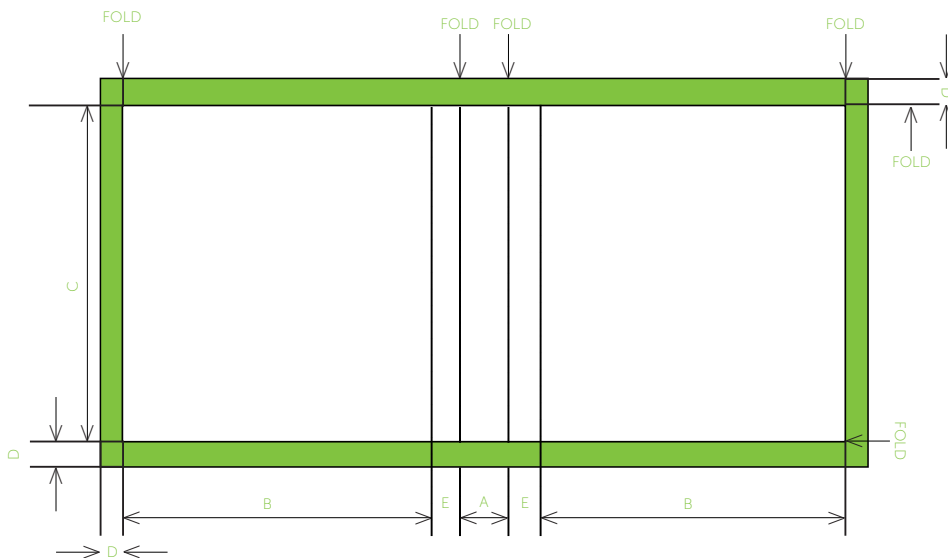

- A** = Spine Bulk + 3mm
- B** = Trimmed page width + 3mm
- C** = Trimmed page Height + 6mm
- D** = 15mm
- E** = 8mm - This area to be considered when designing/ centering images Front and Back

Spine Brass Details

Spine brass PDF to be supplied as 100% black file.

Spine brass files should be supplied at minimum of 2mm narrower than the hollow used on the case, for the hollow size please use CPI calculator for PPC or speak to your customer service executive.

Case Notes

Minimum spine width for cased round backed is 8mm - there is an option to "flat back" books from 4mm-8mm.

Minimum 10mm spine bulk required for 5mm ribbon application (cased only).

Tolerances

Please be aware of manufacturing tolerances due to natural movement during the production process. Please speak with your CPI representative for more information.

PDF settings and samples

Available on request:

Sample of a combined CMYK PDF & Finishing

Indesign Setting for Exporting to PDF

CPI

CPI BOOKS (CHATHAM)

Badger Road, Chatham
Kent, ME5 8TD
+44 (0)16 3467 3200

CPI BOOKS (CROYDON)

108a Beddington lane, Croydon
Surrey, CRO 4YY
+44 (0)20 8688 8300